



## KT-LCD8S User Manual



## Contact Information

### **Electric Bike Outfitters, LLC**

**2530 W Barberrry Place**

**Denver, CO 80204**

**United States**

Phone: +01 720-612-4965

E-mail: [sales@electricbikeoutfitters.com](mailto:sales@electricbikeoutfitters.com)

[www.electricbikeoutfitters.com](http://www.electricbikeoutfitters.com)

## Contents

Preface.....	4
Outlook and Size .....	4
LCD Dimension .....	4
Button Box Dimension .....	5
Main Material and Color.....	5
Wiring Schematic .....	5
Installation Instruction .....	5
Ø 31.8 Handlebar Diameters Install .....	6
Ø 22.2 Handlebar Diameters Install .....	6
Physical Installation .....	7
Function Overview .....	7
Display Content.....	8
Button Definition .....	8
Basic Operation.....	9
On/Off.....	9
Display Interface.....	9
Display of Turned on Throttle .....	10
Pedal Assist Level (or Throttle).....	11
Power Walk Function .....	12
Cruise Function .....	12
Headlight Function.....	13
Brake Status Indicator .....	13
Battery Capacity Indicator .....	14
Motor Operating Power and Temperature .....	15
Ambient Temperature .....	16
Single Data Clearing.....	16
Automatic Prompt Interface .....	17
<i>Error Code Display</i> .....	17

<i>Motor Operating Temperature Alarm</i> .....	17
User Settings .....	18
General Parameter Settings.....	18
Maximum Speed .....	18
Wheel Diameter .....	19
Metric and Imperial Units .....	20
Exit General Parameter Settings.....	20
P Parameter Settings.....	21
P1 Motor Characteristic Parameter Setting.....	21
P2 Wheel Speed Pulse Signal Setting.....	21
P3 Throttle Assist Level Control Setting.....	23
P4 Throttle Activation Setting.....	23
P5 Battery Monitoring Setting.....	24
Exit P Parameter Setting .....	25
C Parameter Settings.....	26
C1 Pedal Assist Sensor Setting .....	26
C2 Motor Phase Classification Coding Setting .....	27
C3 Pedal Assist Ratio Level Setting .....	28
C4 Throttle Function Setting.....	29
C5 Controller Maximum Current Setting.....	30
C6 Screen Brightness Setting.....	31
C7 Cruise Function Setting .....	32
C8 Motor Operating Temperature Display Setting .....	33
C9 Startup Password Setting .....	35
C10 Restore KT Factory Default Setting.....	36
C11 LCD System Version Setting .....	37
C12 Controller Minimum Voltage Setting .....	39
C13 ABS Brakes and Anti-Charge Control Setting .....	41
C14 Pedal Assist Tuning Setting .....	42
L Parameters Setting .....	43

Exit Parameter Setting.....	46
Parameter Copy .....	46
Version Information.....	47
Default Settings .....	49

## Preface

This manual will help the user understand and familiarize themselves the KT-LCD8S function, operations, setting the e-bike parameters, and how to achieve the best match of the e-bike components to improve performance to the electric bike system. The manual covers installation, operation, parameter setting of the display and how to use it properly, which helps users' setup the functionality of the electric bike system.

## Outlook and Size

### ○ LCD Dimension (mm)

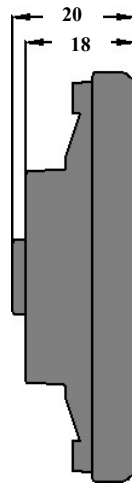
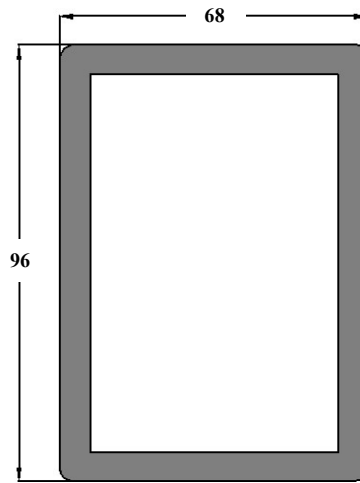

### LCD Dimension (mm)

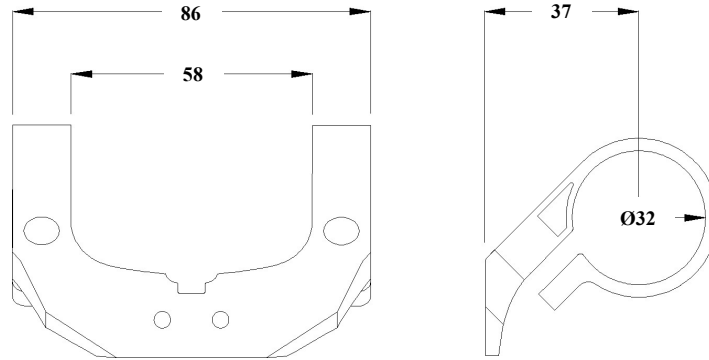

**Dual Bracket Mounting Dimension (mm)**

○ **Button Box Dimension**

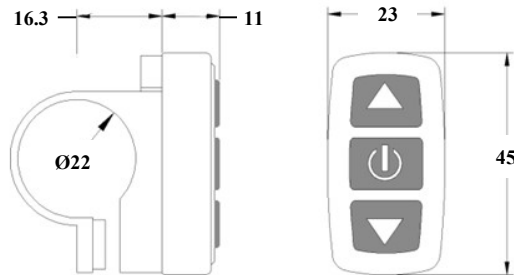

○ **Main Material and Color**

Polycarbonate (PC) material is mainly used for KT-LCD8S and button box housing, and the housing color is black.

○ **Wiring Schematic**

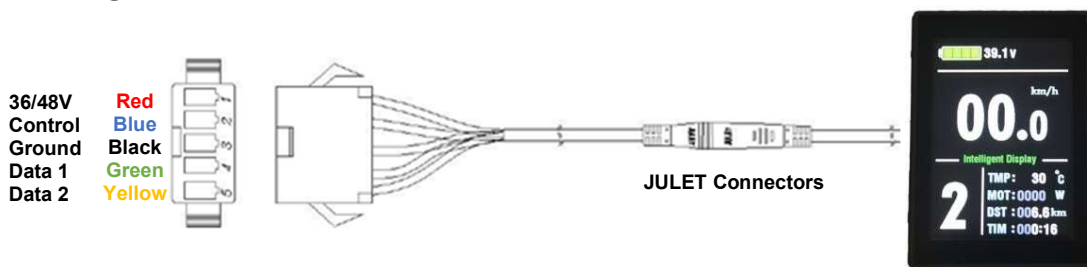

**Installation Instruction**

Using the appropriate methods and fixtures, mount the LCD screen and button box onto the handle bar to the rider's desires. Refer to the following images below for installation on specific handle bar diameters. While the e-bike is off, connect the necessary wiring and check to make sure all connections are firmly attached. Finally, remove the protection film from the display.

○ Ø 31.8 Handlebar Diameters Install

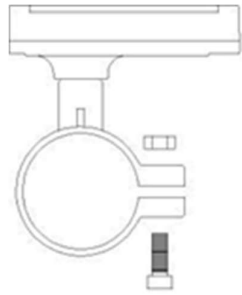

**LCD and Bracket Side View**

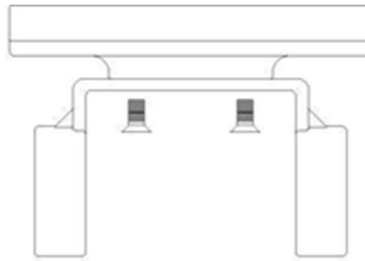

**LCD and Bracket View**

○ Ø 22.2 – 25.4 Handlebar Diameters Install

Optional Encircled Rubber LCD  
Bracket Mounts Ø22.2 or Ø25.4

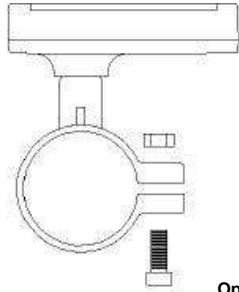
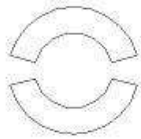

**LCD and Bracket Side View**

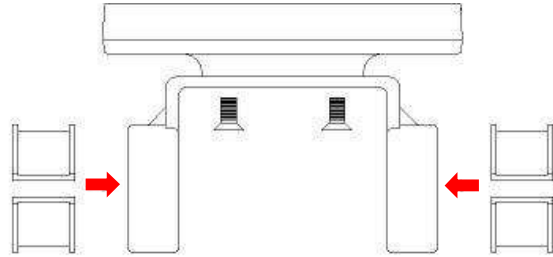

Optional Encircled Rubber LCD  
Bracket Mounts Ø22.2 or Ø25.4

Optional Encircled Rubber LCD  
Bracket Mounts Ø22.2 or Ø25.4

**LCD and Bracket View**



○ Physical Installation

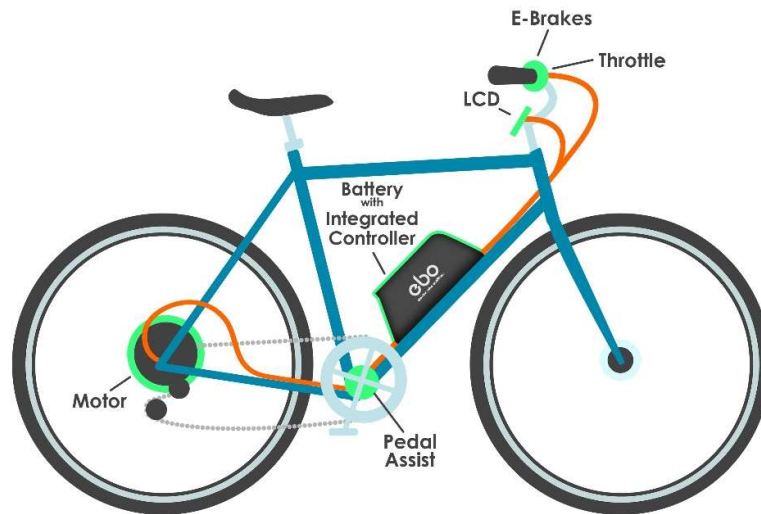

## Function Overview

KT-LCD8S provides a variety of functions such as electric bike controls and electric bike status digitally displayed to meet the trip demands.

- Trip time display (with displays of a single trip time (**TM**) and total trip time (**TTM**));
- Trip speed display (with displays of real-time speed (Km/H or MPH) and a single maximum speed (**MXS**) and a single average speed (**AVS**));
- Trip distance display (with displays of a single trip distance (**DST**) and total trip distance (**ODO**));
- Functions of throttle;
- Functions of pedal assist system;
- Pedal Assist Level (**ASSIST**);
- 6Km/H power walk (🚶) function;
- Cruise function (**CRUISE**);
- Battery capacity indicator (🔋);
- Real-time battery voltage (**VOL**) display;
- Motor power and temperature (**MOTOR**) display;
- Brake display (🛑);

- Turn on backlighting and lights (☰▶);
- Environment temperature (°C or °F) display;
- Data clearing;
- Fault code display;
- User Parameter setting
- 24V, 36V, 48V supply voltage can automatic identification and be compatible

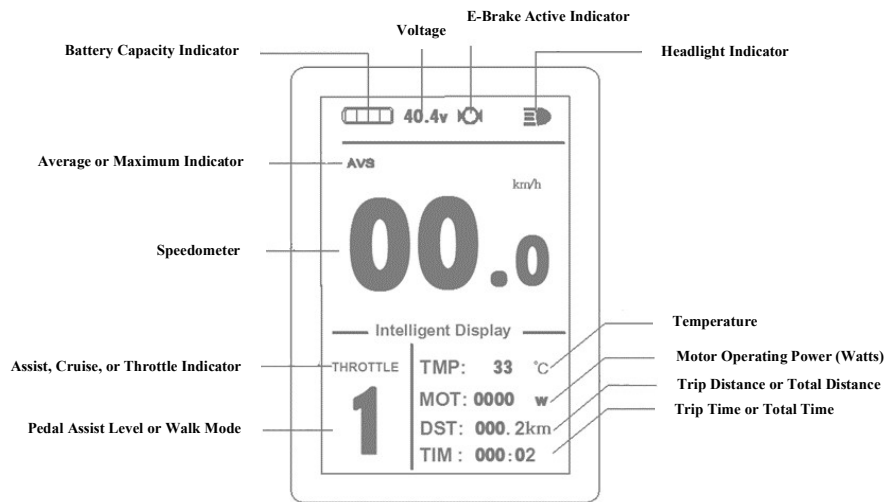

## Display Content

The display content is shown as follow.



## Button Definition

KT-LCD8S is designed with the display in the center of the handlebars and electric bike control buttons next to the left-hand grip of the handlebars for ease and safety.

There are three buttons on the operating panel of the box, which are button  (UP) button  (DOWN) and button  (POWER).

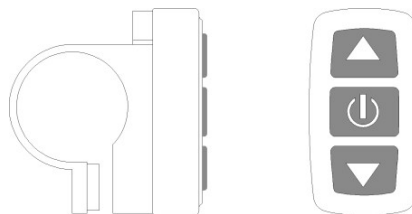

Button Box and Operating Panel

## Basic Operation

### ○ On/Off

To turn on or off, hold down  button for **2 seconds**. System will automatically shut down when stationary and not in use for **5 minutes (Default Setting)**. When powered off, the power consumption of the display and controller is zero.

### ○ Display Interface

Press  power button, the LCD8S is in the startup display 1.

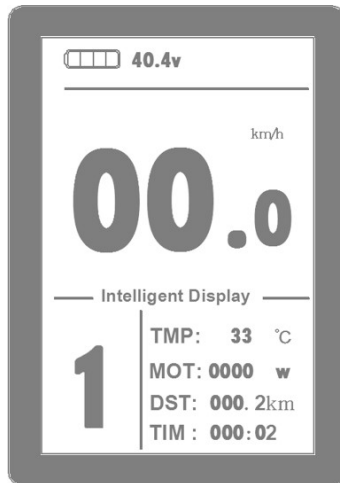

Display 1

In display 1, press  button to enter display 2.

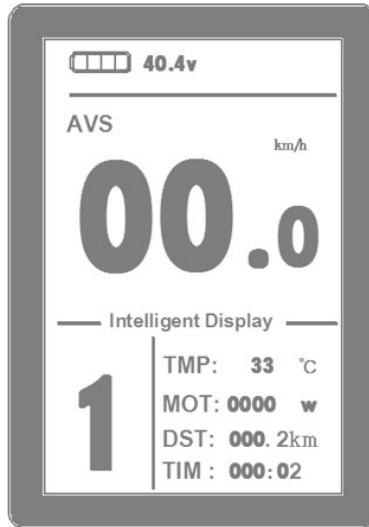

Display 2

**In the riding mode after 5 seconds, display 2 automatically jump to display 1**

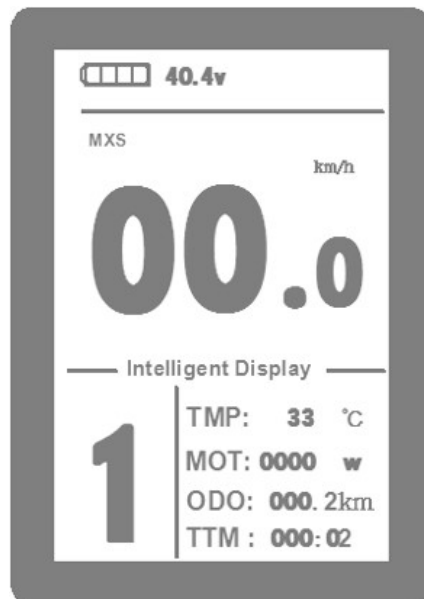

In display mode 2, press  button again to enter display 3.



In each display interface, if you press  button 2 seconds, the display will power off.

### **Throttle Indicator**

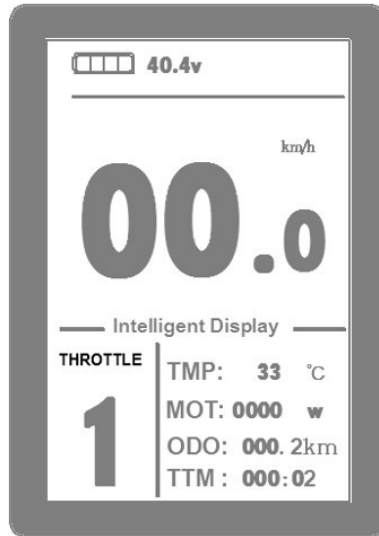
The throttle indicator will show on the display when activated (see figure below).



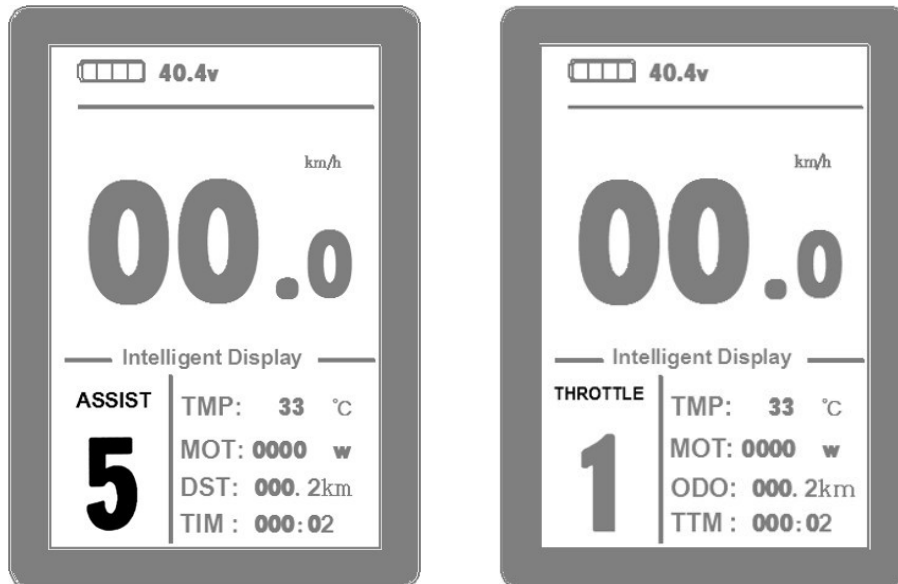

### Pedal Assist System (PAS)

Press  button or  button to adjust the pedal assist level, changing the motor power output. Range of pedal assist is between 1 and 5 (this can also be configured according to the rider's requirements), where one provides the lowest power and five provides the highest. When the PAS level is set to zero, the pedal assist function is off.



Powering on the display will automatically restore PAS level (this can also be configured as required by users) when it was at last shut down. When the pedal assist system is level 0 zero, there's no pedal assist function. Activating the throttle will override the PAS function and will show on display.

## Power Walk Function

Users can use power walk function for assistances while walking alongside the e-bike or riding in crowds. Hold  button and the motor will provide power until e-bike reaches 6 Km/H. The display will show the  indicating the function is active. By releasing the  button, the function will be deactivated.

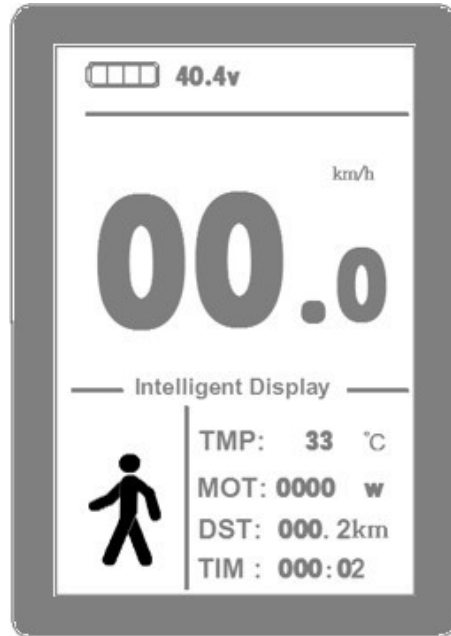

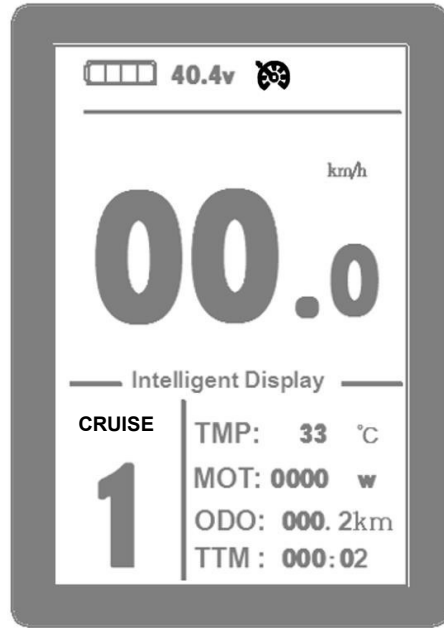

## Cruise Function

When the e-bike is traveling above 7Km/H, hold  button for **3 seconds** to set the cruise function. The LCD8S will display "CRUISE" and "C" to indicate that the cruise function has been activated (as seen in the figure below). Brake or hold any button to deactivate cruise. *Note: This feature only works if it has been activated through the Parameter settings (check C7 in Parameter setting).*



## Headlight Function

To turn on or off headlight, hold  button for **3 seconds**.

When this function is activated, the display will show  sign to indicate it is on (**Note: Controller requires headlight output functions**).

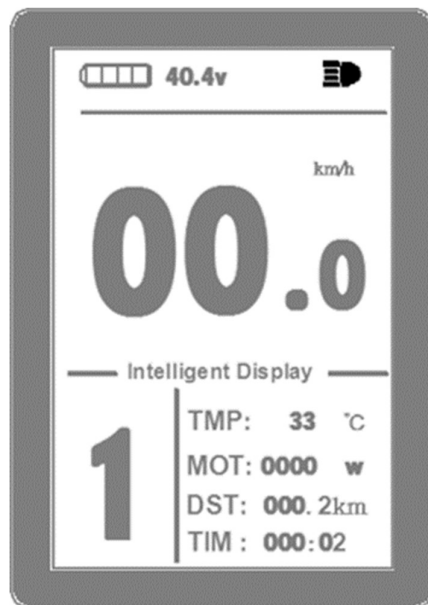

## E-Brake Status Indicator

When e-brake is activated the KT-LCD8S will display (⊗), as shown in the figure.

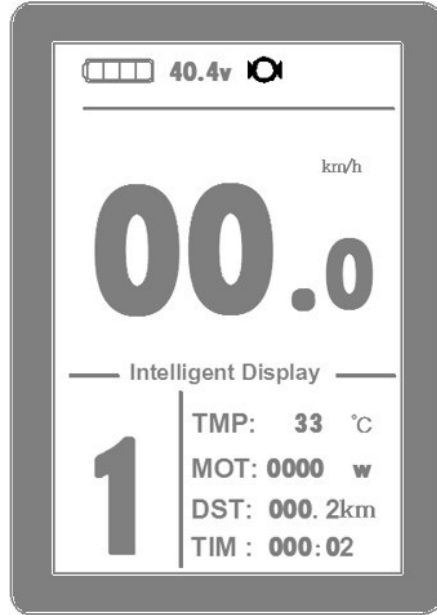

## Battery Capacity Indicator

The KT-LCD8S can identify 24V, 36V, 48V battery capacities when used with supporting controllers. When the battery capacity is over 70%, four bars from the battery indicator will be displayed. As the battery capacities drop, the bars will change accordingly. Once the power capacity is less than 15%, the battery indicator will be empty and show zero bars. If the power display frame flashes, it is due to voltage shortage where the controller will power off.





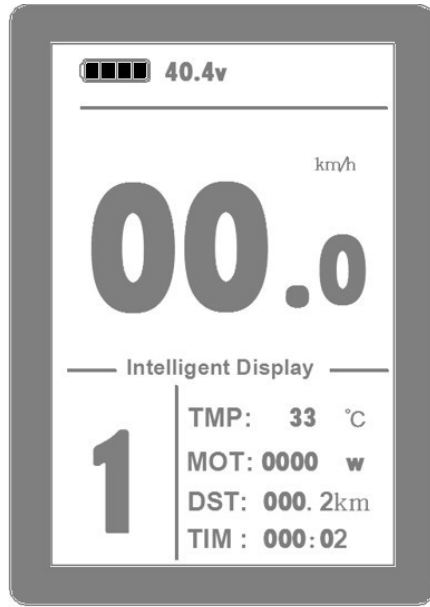

### Motor Operating Power and Temperature

While e-bike motor is in use, real time output power from the motor is displayed on the display. The operating temperature of the motor can be displayed with supporting sensors installed in the motor to output the temperature (adjusted in C8 parameters). When the motor

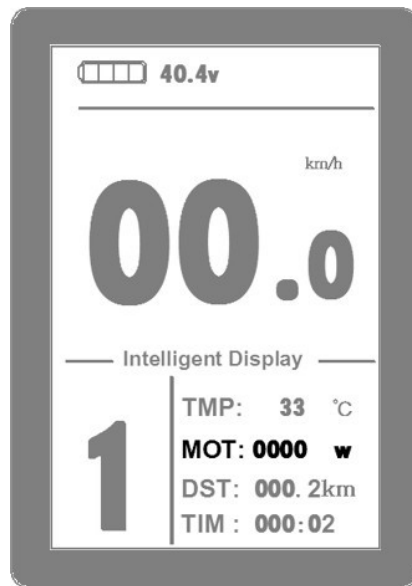



operating temperature exceeds the warning value, temperature display flashes to alarm the rider. In this circumstance, the motor controller will offer the appropriate protection to motor and auto shutoff.

## Ambient Temperature

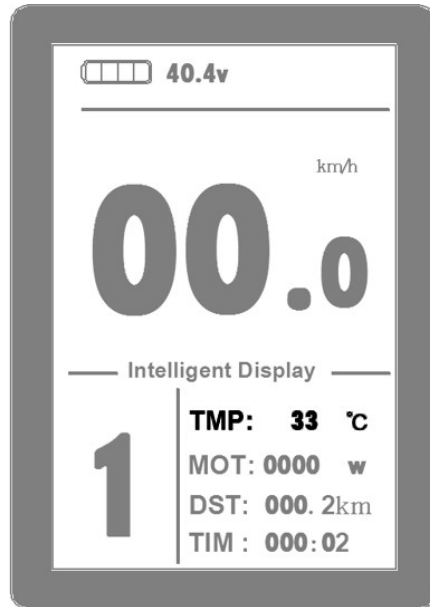
Upon powering up the ambient/environment temperature is displayed on the bottom right hand corner. The displayed figure may not accurately indicate the ambient temperature immediately after start up, however will adjust within 10 minutes.



## Single Data Clearing

After *five seconds* after turning on LCD8S, while on display 1 hold both the  button and the button  simultaneously for *3 seconds*. The single trip time (TM) and single trip distance (DST) will flicker. Press  button and the record contents of both will be cleared. If there are no operations within five seconds of (TM) and (DST) flashing, the LCD8S will return to display 1, and the original record content will be saved.



Under the status of data flashing, if there were no operations on the data within 5 seconds, the LCD8S will automatically return to display1 after 5 seconds, and the original record content will be saved.

### Automatically Prompt Interface

**Error Code Display:** When there are issues with the electronic control system of the e-bike, the LCD will automatically display (flicker) a fault code. This cannot be removed until fault is fixed. Refer to **Error Code & Definition Table** for reference.

Error Code	Definition
<b>Motor position sensor fault!</b>	Failure of electronic control system
<b>THROTTLE fault!</b>	Malfunction of the operation



**Motor operating temperature alarm:** When the motor operating temperature exceeds the warning value, the motor operating temperature display flashes to alarm the rider, while the controller will provide the appropriate protection to the motor

## User Setting

KT-LCD8S user parameter settings:



- General parameter settings
- P parameter settings
- C parameter settings
- L parameter settings

## General Parameter Settings

To enter the parameter setting, simultaneously hold  button and  button for **3 seconds** within **5 seconds** of turning the LCD8S on.

**When the parameter setting are idle for more than 1 minute the then the LCD will automatically return to display 1, and the original set values will be saved.**





### Maximum Trip Speed

LIM (Limit) and the speed will be displayed, indicating the maximum riding speed (Refer to image below for illustration). To adjust, press the  button to increase or  button to decrease the speed. Once desired speed has been selected, press the  button to confirm changes and move onto wheel diameter.



SETTING	
▶LIM : 50km/h	C6 : 3
DIM : 26"	C7 : 1
UNT : 0	C8 : 0
P1 : 192	C9 : 0
P2 : 1	C10 : N
P3 : 1	C11 : 0
P4 : 0	C12 : 4
P5 : 12	C13 : 0
C1 : 7	C14 : 2
C2 : 1	L1 : 0
C3 : 1	L2 : 0
C4 : 4	L3 : 1
C5 : 10	L4 : 5

After finishing the maximum riding speed setting, press  button to save the current set values.





## Wheel Diameter

After confirming the maximum riding speed setting, press  button (**DOWN**) to enter the wheel diameter setting interface, press  button to confirm, and then the wheel diameter display column flashes. Press  button (**UP**) or  button (**DOWN**) to choose the corresponding wheel diameter specification to the e-bike. The selection of wheel diameter sizes is 5, 6, 8, 10, 12, 14, 16, 18, 20, 22, 24, 26, 700c, 28 and 29 inches.

SETTING	
LIM : 50km/h	C6 : 3
▶DIM : 26"	C7 : 1
UNT : 0	C8 : 0
P1 : 192	C9 : 0
P2 : 1	C10 : N
P3 : 1	C11 : 0
P4 : 0	C12 : 4
P5 : 12	C13 : 0
C1 : 7	C14 : 2
C2 : 1	L1 : 0
C3 : 1	L2 : 0
C4 : 4	L3 : 1
C5 : 10	L4 : 5



After finishing the wheel diameter setting, press  button to save the current set specification, then press  button (**DOWN**) enter into the next setting.

## Metric and Imperial Units

After finishing the wheel diameter setting, press  button (**DOWN**) to enter the metric/imperial units setting interface, press  button, and then the speed and mileage unit flash. Press  button (**UP**) or  button (**DOWN**) to make selection of the 4 codes for metric/imperial units as speed, mileage, and the ambient temperature.

Definition Table of Metric/Imperial Units:

Code	Speed	Mileage	Ambient temperature
0	Km/h	Km	°C (Centigrade)
1	MPH	Mil	°C (Centigrade)
2	Km/h	Km	°F (Fahrenheit)
3	MPH	Mil	°F (Fahrenheit)



After finishing the metric/imperial units setting, press  button to save the current set values, and then speed and mileage units stop flashing, or hold  button for 2 seconds to exit the general parameter setting and return to display 1 at any time.

## P Parameter Setting

Enter the P parameter settings by pressing  button (**DOWN**) to enter P Parameters Setting.



### P1 Motor Characteristic Parameter Setting

P1 = Motor Gear Reduction Ratio x Number of motor Magnets (Rounding if necessary)

P1 setting ranges between 1-255, press  button (**UP**) or  button (**DOWN**) for selection.

SETTING	
LIM : 50km/h	C6 : 3
DIM : 26"	C7 : 1
UNT : 0	C8 : 0
▶P1 : 192	C9 : 0
P2 : 1	C10 : N
P3 : 1	C11 : 0
P4 : 0	C12 : 4
P5 : 12	C13 : 0
C1 : 7	C14 : 2
C2 : 1	L1 : 0
C3 : 1	L2 : 0
C4 : 4	L3 : 1
C5 : 10	L4 : 5

P1 parameter setting interface



After finishing P1 parameter setting, press  button to save the current set values and press  button (**DOWN**) to enter P2 parameter setting.

### P2 Wheel Speed Pulse Signal Setting

P2 parameter setting interface, then press  button P2 parameter column flashes.

SETTING	
LIM : 50km/h	C6 : 3
DIM : 26"	C7 : 1
UNT : 0	C8 : 0
P1 : 192	C9 : 0
▶P2 : 1	C10 : N
P3 : 1	C11 : 0
P4 : 0	C12 : 4
P5 : 12	C13 : 0
C1 : 7	C14 : 2
C2 : 1	L1 : 0
C3 : 1	L2 : 0
C4 : 4	L3 : 1
C5 : 10	L4 : 5

P2 parameter setting interface

The P2 Parameter is a setting mode for wheel speed pulse signal. If wheel generated 1 pulse signal by a revolution, the P2 value should be set to 1. If the wheel generated 6 pulse signals by a revolution, P2 should be set as 6. If users did not configure the Parameter then P2 can be set to 0. The selection of P2 values ranges from 0 to 6, press  button (**UP**) or  button (**DOWN**) for selection.

**Please Note:** When P2 parameter is set to be 0, for the built-in clutch motor, when the internal motor rotors stop or the internal rotor speed is lower than the outer rotor speed, the speed displayed on the LCD will be inaccurate.

After finishing P2 parameter setting, press  button to save the current set values, then press  button (**DOWN**) to enter P3 parameter setting.







### P3 Throttle Assist Level Control Setting

Enter P3 parameter setting after P2 parameter setting is finished, press button and P3  parameter column flashes.

SETTING	
LIM : 50km/h	C6 : 3
DIM : 26"	C7 : 1
UNT : 0	C8 : 0
P1 : 192	C9 : 0
P2 : 1	C10 : N
▶P3 : 1	C11 : 0
P4 : 0	C12 : 4
P5 : 12	C13 : 0
C1 : 7	C14 : 2
C2 : 1	L1 : 0
C3 : 1	L2 : 0
C4 : 4	L3 : 1
C5 : 10	L4 : 5

P3 parameter setting interface

P3 Parameters affect the pedal assist system (PAS) control setting. When the value is set to 0, the throttle is dependent on the PAS level ratio. This means when the PAS level ratio is 1, the throttle will provide the least amount of power, whereas when it is 5, the throttle will provide the most power. If the P3 Parameter is set to 1, the throttle independent from assist levels and will provide maximum power regardless of the PAS level chosen.

Press  button (UP) or  button (DOWN) for selection. After finishing P3 parameter setting, press  button to save the current set values, then press  button (DOWN) to enter P4 parameter setting interface.

### P4 Throttle Activation Setting

Enter P4 parameter setting after P3 parameter setting is finished, press  button, P4 parameter column flashes.

SETTING	
LIM : 50km/h	C6 : 3
DIM : 26"	C7 : 1
UNT : 0	C8 : 0
P1 : 192	C9 : 0
P2 : 1	C10 : N
P3 : 1	C11 : 0
▶P4 : 0	C12 : 4
P5 : 12	C13 : 0
C1 : 7	C14 : 2
C2 : 1	L1 : 0
C3 : 1	L2 : 0
C4 : 4	L3 : 1
C5 : 10	L4 : 5

P4 parameter setting interface

The P4 settings is for controlling the throttle activation. When the P4 Parameter is 1, the throttle is under "delayed startup" where the throttle will only activate the motor after the motor has been activated via Pedal Assist System. Setting the P4 to 0 will set the throttle to activate the motor when triggered.

### P5 Power Monitoring Setting

Enter P5 parameter setting interface after P4 parameter setting is finished, press  button, P5 parameter column flashes.

SETTING	
LIM : 50km/h	C6 : 3
DIM : 26"	C7 : 1
UNT : 0	C8 : 0
P1 : 192	C9 : 0
P2 : 1	C10 : N
P3 : 1	C11 : 0
P4 : 0	C12 : 4
▶P5 : 12	C13 : 0
C1 : 7	C14 : 2
C2 : 1	L1 : 0
C3 : 1	L2 : 0
C4 : 4	L3 : 1
C5 : 10	L4 : 5

P5 parameter setting interface

The P5 Parameter is power monitoring mode. When the value is set to 0, the power monitoring is in "real-time voltage" mode where the method to determine the battery capacity is based on real-time voltage. Once the P5 Parameter is set to a specified value, the power monitoring is in "smart power" mode where the value set is determined by the battery characteristics. Such that, 24V lithium batteries are typically set between 4-11, 36V lithium batteries set between 5-15 and 48V lithium batteries set between 12-20. The P5 Parameter setting ranges from 0-40.

### Exit P Parameter Setting

Among the five P parameter settings, when each parameter setting is completed, if

held  button for about 2 seconds, all can exit the setting and return to display 1, and the current set parameters will be saved.

Under each parameter setting interface, if there's no button operation on the display for more than 1 minute, and then the display will automatically return to display 1, and the original set parameters will be saved.

## C Parameter Setting

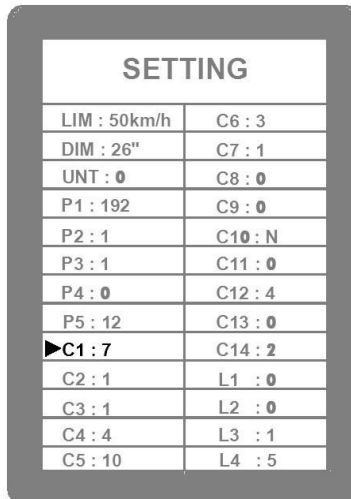

### C1 Power-Assist Sensor and Parameter Select Setting

Set C1 parameter first after entering C parameter setting environment, press  button, C1 parameter column flashes.



SETTING	
LIM : 50km/h	C6 : 3
DIM : 26"	C7 : 1
UNT : 0	C8 : 0
P1 : 192	C9 : 0
P2 : 1	C10 : N
P3 : 1	C11 : 0
P4 : 0	C12 : 4
P5 : 12	C13 : 0
▶C1 : 7	C14 : 2
C2 : 1	L1 : 0
C3 : 1	L2 : 0
C4 : 4	L3 : 1
C5 : 10	L4 : 5

C1 parameter setting interface

C1 is power-assist sensor and parameter select setting, its definition is shown in following table. C1 setting ranges between 0-3, press  button (UP) or  button (DOWN) for selection.

C1 parameter definition table:





Pedal Assist System Forward Plastic Sensors Disc	C1 Value	Start Sensitivity
Forward 5 Magnet Signal	00	Standard
	01	Lower
	02	Lowest
Forward 8 Magnet Signal	00	Higher
	01	Standard
	02	Lower
Forward 10 Magnet Signal	01	Highest
	02	Standard
	03	Lower
Forward 12 Magnet Signal	01	Highest
	02	Higher
	03	Standard

## C2 Motor Phase Classification Coding Setting

The C2 parameter setting interface after C1 parameter setting is finished, press  button, C2 parameter column flashes.

SETTING	
LIM : 50km/h	C6 : 3
DIM : 26"	C7 : 1
UNT : 0	C8 : 0
P1 : 192	C9 : 0
P2 : 1	C10 : N
P3 : 1	C11 : 0
P4 : 0	C12 : 4
P5 : 12	C13 : 0
C1 : 7	C14 : 2
▶C2 : 1	L1 : 0
C3 : 1	L2 : 0
C4 : 4	L3 : 1
C5 : 10	L4 : 5

C2 parameter setting interface



C2 Parameters set the different phases of the motor when using a sine wave drive. The default value is 0, indicating that the used Quantum motor phase is standard. When the Parameter is set as a specified value, a particular motor phase is selected. The range of values for C2 are between 0-7, press  button (**UP**) or  button (**DOWN**) for selection. After finishing C2 parameter setting, press  button to save the current value and then press  button (**DOWN**) to enter C3 parameter setting interface.

### C3 Pedal Assist Level Initialization Setting

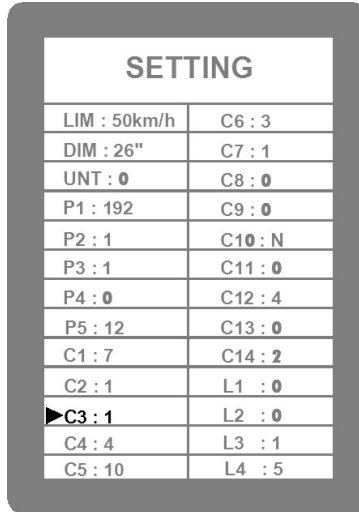
Enter C3 parameter setting interface after C2 parameter setting is finished, press  button, C3 parameter column flashes. Settings for the pedal assist level is 0 – 8.



C3 parameter setting interface

Press  button (UP) or  button (DOWN) for selection C3 parameter values.

The factory default is 8.

C3 parameter values:

C3	Parameter value meaning
0	The LCD is powered on, the pedal assist level is at 0.
1	The LCD is powered on, the pedal assist level is at 1.
2	The LCD is powered on, the pedal assist level is at 2.
3	The LCD is powered on, the pedal assist level is at 3.
4	The LCD is powered on, the pedal assist level is at 4.
5	The LCD is powered on, the pedal assist level is at 5.
6&7	Retain
8	Automatically restore PAS level from last shutdown.

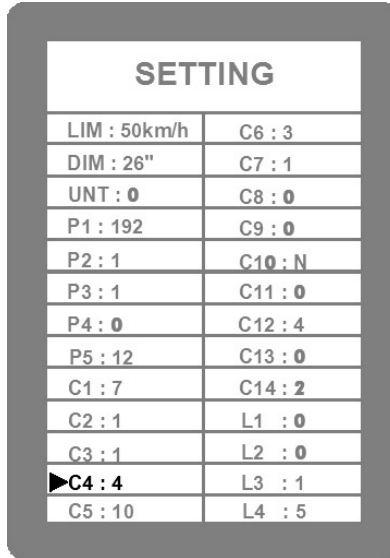

## C4 Throttle Function Setting

Enter C4 parameter setting interface after C3 parameter setting is finished, press  button C4 parameter column flashes.









SETTING	
LIM : 50km/h	C6 : 3
DIM : 26"	C7 : 1
UNT : 0	C8 : 0
P1 : 192	C9 : 0
P2 : 1	C10 : N
P3 : 1	C11 : 0
P4 : 0	C12 : 4
P5 : 12	C13 : 0
C1 : 7	C14 : 2
C2 : 1	L1 : 0
C3 : 1	L2 : 0
▶C4 : 4	L3 : 1
C5 : 10	L4 : 5

C4 parameter setting interface

C4 is throttle function setting, the setting range is 0-4, press  button (UP) or  button (DOWN) for selection.

C4 parameter definition table:

C4 Value	Throttle in PAS Level = 0	Throttle in PAS Level = 1 - 5
0	No Throttle	Full Throttle Control
1	No Throttle	Throttle Limited to 6Km/h
2	No Throttle	Throttle Speed Programmed to Rider's Specification
3	Full Throttle Control	Full Throttle Control
4	No Throttle	Throttle is Dependent of PAS Level and Entered Ratio: 30 - 60

When C4 = 2, the speed limit value of throttle flashes, press  (UP) button or  (DOWN) button to make selection, and the default value is 20. When C4 = 4 the value is the percentage speed with power assist level, press  (UP) button or  (DOWN) button for selection, and the default value is 50%. The percentage values of other levels calculate automatically. After finishing C4 parameter setting, press  button to save the current value and then press  button (**DOWN**) to enter C5 parameter setting interface.

### C5 Controller Maximum Current Adjustment Setting



Enter C5 parameter setting interface after C4 parameter setting is finished, press  button, C5 parameter column flashes.

SETTING	
LIM : 50km/h	C6 : 3
DIM : 26"	C7 : 1
UNT : 0	C8 : 0
P1 : 192	C9 : 0
P2 : 1	C10 : N
P3 : 1	C11 : 0
P4 : 0	C12 : 4
P5 : 12	C13 : 0
C1 : 7	C14 : 2
C2 : 1	L1 : 0
C3 : 1	L2 : 0
C4 : 4	L3 : 1
 C5 : 10	L4 : 5



## C5 Parameter Controller Maximum Current Setting



C5 settings are for controlling the maximum operating current. The default value is 10 and value ranges from 0 to 10. Refer to table below for definition of each value.

The default value is 10, setting range is 0-10, press  button (**UP**) or  button (**DOWN**) for selection.

C5 Parameter Definition Table:

C5 value	Maximum current value(A)
00	Three level slow start/ Maximum current value
01	Two level slow start/ Maximum current value
02	One level slow start/ Maximum current value
03	Maximum current value $\div$ 2.00
04	Maximum current value $\div$ 1.50
05	Maximum current value $\div$ 1.33
06	Maximum current value $\div$ 1.25
07	Maximum current value $\div$ 1.20
08	Maximum current value $\div$ 1.15
09	Maximum current value $\div$ 1.10
10	Maximum current value

When C5 setting is 10, maximum current value is controller maximum operating current value (i.e., limit current value); when setting is 9, maximum current value divided by 1.10, when setting is 8, maximum current value divided by 1.15 and so on.

After finishing C5 parameter setting, press  button to save the current value and then press  button (**DOWN**) to enter C6 parameter setting interface.

## C6 Screen Brightness Adjustment Setting

Enter C6 parameter setting interface after C5 parameter setting is finished, press  button, C6 parameter column flashes.

SETTING	
LIM : 50km/h	▶ C6 : 3
DIM : 26"	C7 : 1
UNT : 0	C8 : 0
P1 : 192	C9 : 0
P2 : 1	C10 : N
P3 : 1	C11 : 0
P4 : 0	C12 : 4
P5 : 12	C13 : 0
C1 : 7	C14 : 2
C2 : 1	L1 : 0
C3 : 1	L2 : 0
C4 : 4	L3 : 1
C5 : 10	L4 : 5



C6 parameter setting interface

C6 is the meter backlight brightness adjustment setting, the default value is 3, and

setting range is 1-5, press  button (**UP**) or  button (**DOWN**) for selection.

C6 parameter definition table:

C6 value	Screen Brightness
1	Dimmest
2	Dim
3	Standard
4	Brighter
5	Brightest

After finishing C6 parameter setting, press  button to save the current value and then press  button (**DOWN**) to enter C7 parameter setting interface.



### C7 Cruise Function Setting

Enter C7 parameter setting interface after C6 parameter setting is finished, press 

button, C7 parameter column flashes.



SETTING	
LIM : 50km/h	C6 : 3
DIM : 26"	▶ C7 : 1
UNT : 0	C8 : 0
P1 : 192	C9 : 0
P2 : 1	C10 : N
P3 : 1	C11 : 0
P4 : 0	C12 : 4
P5 : 12	C13 : 0
C1 : 7	C14 : 2
C2 : 1	L1 : 0
C3 : 1	L2 : 0
C4 : 4	L3 : 1
C5 : 10	L4 : 5

C7 parameter setting interface

C7 is cruise function setting, the setting range is 0 or 1, press  button (UP) or  button (DOWN) for selection.

C7 parameter definition table:

C7 value	Cruise function
0	Off
1	On

After finishing C7 parameter setting, press  button (SW) to save the current value and then press  button (DOWN) to enter C8 parameter setting interface.

### C8 Motor Operating Temperature Display Setting

Enter C8 parameter setting interface after C7 parameter setting is finished, press  button C8 parameter column flashes.

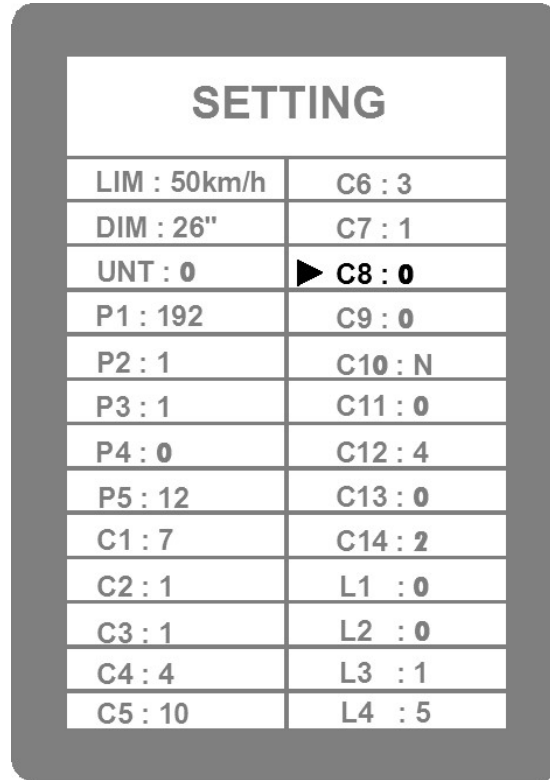

C8 parameter setting interface



C8 is motor operating temperature display setting, the setting range is 0 or 1,

press  button (UP) or  button (DOWN) for selection.

C8 parameter definition table:

C8 value	Motor operating temperature
0	Function off
1	Function on

**Please Note:** The motor operating temperature display requires installing temperature sensor in the motor, output temperature detection signal simultaneously.

After finishing C8 parameter setting, press  button (SW) to save the current value and then press  button (DOWN) to enter C9 parameter setting interface.

## C9 Startup Password Setting

Enter C9 parameter setting interface after C8 parameter setting is finished, press



button, C9 parameter column flashes.

SETTING	
LIM : 50km/h	C6 : 3
DIM : 26"	C7 : 1
UNT : 0	C8 : 0
P1 : 192	▶ C9 : 0
P2 : 1	C10 : N
P3 : 1	C11 : 0
P4 : 0	C12 : 4
P5 : 12	C13 : 0
C1 : 7	C14 : 2
C2 : 1	L1 : 0
C3 : 1	L2 : 0
C4 : 4	L3 : 1
C5 : 10	L4 : 5

C9 Parameter Setting Interface

C9 is meter power-on password setting, the default value is 0, press button (**UP**)

or button (**DOWN**) for selection.

C9 parameter definition table:

C9 value	Startup password setting
0	Function off
1	Function on

When C9 setting is 1, indicating that the password function is on and then enter the password settings interface, three-digit password setting columns flash.

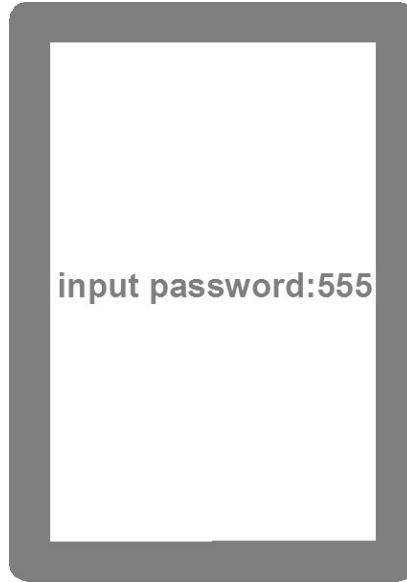



Password Setting Interface

The password setting is done sequentially from left to right, press  button to confirm after each setting and enter next setting. Password setting range is 000-999, press

 button (**UP**) or  button (**DOWN**) for selection.

**PLEASE NOTE:** If password is forgotten, the Parameters can only be copied (see Parameter copy) by data source LCD prior to being decoded.

After finishing C9 parameter setting, press  button to save the current value and then press  button (**DOWN**) to enter C10 parameter setting interface.

### **C10 Restore Default Setting**

Enter C10 parameter setting interface after C9 parameter setting is finished, press  button, C10 parameter column flashes.

SETTING	
LIM : 50km/h	C6 : 3
DIM : 26"	C7 : 1
UNT : 0	C8 : 0
P1 : 192	C9 : 0
P2 : 1	▶ C10 : N
P3 : 1	C11 : 0
P4 : 0	C12 : 4
P5 : 12	C13 : 0
C1 : 7	C14 : 2
C2 : 1	L1 : 0
C3 : 1	L2 : 0
C4 : 4	L3 : 1
C5 : 10	L4 : 5

C10 Parameter Setting Interface



C10 is automatic restore default settings, the default is N, and the setting can be N, or

Y, press  button (**UP**) or  button (**DOWN**) for selection.

C10 parameter definition table:

C10 value	Restore default setting
N	Function off
Y	Function on

To restore the LCD to default settings, select the C10 value "y" to enable the function and hold the  button for **2 seconds**. All Parameters will restore to default values and the LCD will return to display 1.

After finishing C10 parameter setting, press  button to save the current value and then press  button (**DOWN**) to enter C11 parameter setting interface.

## C11 LCD Attribute Selection Setting

Enter C11 parameter setting interface after C10 parameter setting is finished, press  button, C11 parameter column flashes.

SETTING	
LIM : 50km/h	C6 : 3
DIM : 26"	C7 : 1
UNT : 0	C8 : 0
P1 : 192	C9 : 0
P2 : 1	C10 : N
P3 : 1	▶ C11 : 0
P4 : 0	C12 : 4
P5 : 12	C13 : 0
C1 : 7	C14 : 2
C2 : 1	L1 : 0
C3 : 1	L2 : 0
C4 : 4	L3 : 1
C5 : 10	L4 : 5

C11 parameter setting interface

C11 is meter attribute selection setting, the setting range is 0-2, press  button

(UP) or  button (DOWN) for selection.

C11 Parameter Settings Table:



C11 value	Meter Attribute
0	LCD uses LCD8S new version of communication protocol, it is compatible LCD1 and LCD2.
1	LCD uses LCD1 and LCD2 old version communication protocol, it is not compatible LCD8S.
2	As data source for copying parameters, the LCD transfers the new LCD8S parameter to other LCDs.



C11 selects 2, hold  for 2 seconds to exit the setting environment, and then the LCD is served as data source for copying parameter (see parameter copy), there's source logo on display interface.

DATA SOURCE	
LIM : 50km/h	C6 : 3
DIM : 26"	C7 : 1
UNT : 0	C8 : 0
P1 : 192	C9 : 0
P2 : 1	C10 : N
P3 : 1	▶ C11 : 2
P4 : 0	C12 : 4
P5 : 12	C13 : 0
C1 : 7	C14 : 2
C2 : 1	L1 : 0
C3 : 1	L2 : 0
C4 : 4	L3 : 1
C5 : 10	L4 : 5

Data Source Display Interface



After finishing C11 parameter setting, press  button (SW) to save the current value and then press  button (DOWN) to enter C12 parameter setting interface.

## C12 Controller Minimum Voltage Setting

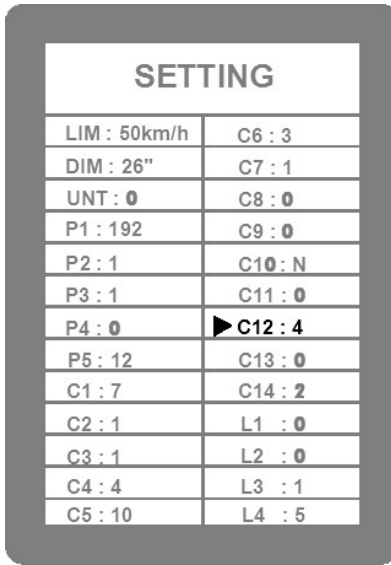
Enter C12 parameter setting interface after C11 parameter setting is finished, press  button, C12 parameter column flashes.





C12 parameter setting interface

C12 Parameters are settings for the controller's minimum operating voltage (voltage shortage value), the default value is 4, and the setting range is 0-7, press  button (UP) or  button (DOWN) for selection.

C12 parameter definition table:

C12 Value	Minimum Voltage (V)		
	24V Controller	36V Controller	48V Controller
0	Default Value-2V	Default Value-2V	Default Value-2V
1	Default Value-1.5V	Default Value-1.5V	Default Value-1.5V
2	Default Value-1V	Default Value-1V	Default Value-1V
3	Default Value-0.5V	Default Value-0.5V	Default Value-0.5V
4	Default Value=20V	Default Value=30V	Default Value=40V
5	Default Value+0.5V	Default Value+0.5V	Default Value+0.5V
6	Default Value+1V	Default Value+1V	Default Value+1V
7	Default Value+1.5V	Default Value+1.5V	Default Value+1.5V

C12 default value is 4, controller minimum operating voltage (voltage shortage value); when setting is 5, the default value plus 0.5V, when setting is 4, the default value minus 0.5V and so on. After finishing C12 parameter setting, press  button to save the current value and then press  button (DOWN) to enter C13 parameter setting interface.

### C13 ABS Brakes and Recharge Control Setting

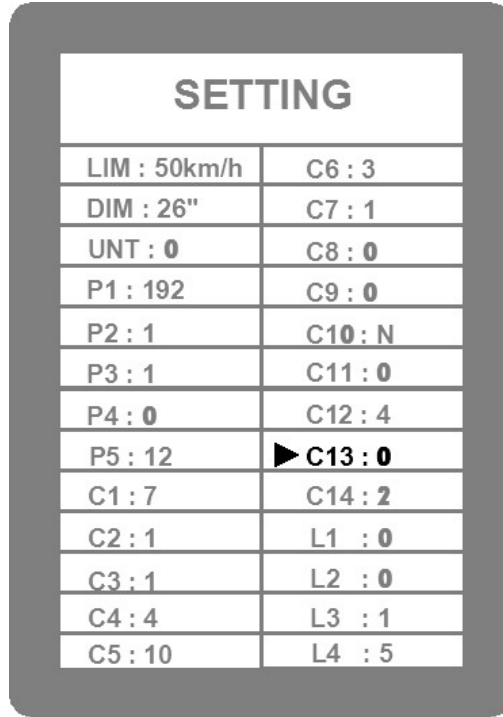

Enter C13 parameter setting interface, press  button C13 parameter bar flashes.



SETTING	
LIM : 50km/h	C6 : 3
DIM : 26"	C7 : 1
UNT : 0	C8 : 0
P1 : 192	C9 : 0
P2 : 1	C10 : N
P3 : 1	C11 : 0
P4 : 0	C12 : 4
P5 : 12	▶ C13 : 0
C1 : 7	C14 : 2
C2 : 1	L1 : 0
C3 : 1	L2 : 0
C4 : 4	L3 : 1
C5 : 10	L4 : 5

C13 Parameter Setting Interface

C13 Parameters are settings for the ABS braking strength and anti-charge control. The



default value is 0 with the setting range between 0-5, press  (UP) button or  (DOWN) button to make selection.

C13 parameter definition table:

C13 Value	ABS Braking Strength	Energy Recovery Efficiency
0	None	None
1	Class 1 Braking Strength	Best energy recovery
2	Class 2 Braking Strength	General energy recovery
3	Class 3 Braking Strength	Weaker energy recovery
4	Class 4 Braking Strength	Poor energy recovery
5	Class 5 Braking Strength	Bad energy recovery

The recommended value for the C13 Parameter is 1. Other options should be selected with caution for use. Seek professional advice for assistance.

**Be sure to note:** the higher the braking intensity level, the higher the braking strength will be which results in greater damage to the motor shaft.

After finishing C13 parameter setting, press  button to save the current value and then press  button (**DOWN**) to enter C14 parameter setting interface.

### C14 Pedal Assist Tuning Parameters Setting

Enter C14 parameter setting interface, press  button, C14 parameter bar flashes.

SETTING	
LIM : 50km/h	C6 : 3
DIM : 26"	C7 : 1
UNT : 0	C8 : 0
P1 : 192	C9 : 0
P2 : 1	C10 : N
P3 : 1	C11 : 0
P4 : 0	C12 : 4
P5 : 12	C13 : 0
C1 : 7	 C14 : 2
C2 : 1	L1 : 0
C3 : 1	L2 : 0
C4 : 4	L3 : 1
C5 : 10	L4 : 5

C14 Parameter Setting Interface

C14 is the parameters of power-assist tuning setting, with the default value of 2. The power-assist is between 1-4 gear, and it is invalid until P3 equals to 1. The setting range 1-3,

and press  (UP) button or  (DOWN) button for short to make selection.

C14 parameter definition table:

C14 Value	Assist strength of intelligent pedal motor
1	Weak assist strength of motor
2	General assist strength of motor
3	Stronger assist strength of motor

After finishing C14 parameter setting, hold  button for about 2 seconds to exit C parameter setting environment and return to the display 1.

## L Parameter Setting

### L1 Parameter Settings

L1 parameters are applicable to the automatic under-voltage controller. The default of the factory is 0.

- L1=0, the automatic under-voltage controller can automatically select the under-voltage value according to the battery voltage.
- L1=1, the under-voltage value of the automatic under-voltage controller is forced to be 20V.
- L1 = 2, the under-voltage value of the automatic under-voltage controller is forced to be 30V
- L1 = 3, the under-voltage value of the automatic under-voltage controller is forced to be 40V.

SETTING	
LIM : 50km/h	C6 : 3
DIM : 26"	C7 : 1
UNT : 0	C8 : 0
P1 : 192	C9 : 0
P2 : 1	C10 : N
P3 : 1	C11 : 0
P4 : 0	C12 : 4
P5 : 12	C13 : 0
C1 : 7	C14 : 2
C2 : 1	▶ L1 : 0
C3 : 1	L2 : 0
C4 : 4	L3 : 1
C5 : 10	L4 : 5

## L2 Parameter Settings

L2 parameter is suitable for the super high-speed motor controller. The default setting is 0. L2 parameter will be activated when the value of P1 parameter exceeds 255. L2 parameter should use in combination with P1.

- L2=0, P1 parameter is set as the calculated value.
- L2=1, P1 parameter is set as a half of the calculated value.

SETTING	
LIM : 50km/h	C6 : 3
DIM : 26"	C7 : 1
UNT : 0	C8 : 0
P1 : 192	C9 : 0
P2 : 1	C10 : N
P3 : 1	C11 : 0
P4 : 0	C12 : 4
P5 : 12	C13 : 0
C1 : 7	C14 : 2
C2 : 1	L1 : 0
C3 : 1	▶ L2 : 0
C4 : 4	L3 : 1
C5 : 10	L4 : 5

## L3 Parameter Settings

L3 parameter is applicable to the dual mode controller. The default setting is 1.

- L3=0, The controller will activate non-hall model only when hall sensor in the motor fails.
- L3=1, the controller will choose the proper model to use according to the controller system optimization

SETTING	
LIM : 50km/h	C6 : 3
DIM : 26"	C7 : 1
UNT : 0	C8 : 0
P1 : 192	C9 : 0
P2 : 1	C10 : N
P3 : 1	C11 : 0
P4 : 0	C12 : 4
P5 : 12	C13 : 0
C1 : 7	C14 : 2
C2 : 1	L1 : 0
C3 : 1	L2 : 0
C4 : 4	▶ L3 : 1
C5 : 10	L4 : 5

### L4 Parameter Settings

L4 parameter setting is to adjust the delay time of automatic shutdown of the LCD, the default value is 5, and the range of adjust is 5-120 minutes.

- L4=5, the delay time is 5 minutes.
- L4=6, the delay time is 6 minutes.
- L4=7, the delay time is 7 minutes.
- L4=120, the delay time is 120 minutes.

SETTING	
LIM : 50km/h	C6 : 3
DIM : 26"	C7 : 1
UNT : 0	C8 : 0
P1 : 192	C9 : 0
P2 : 1	C10 : N
P3 : 1	C11 : 0
P4 : 0	C12 : 4
P5 : 12	C13 : 0
C1 : 7	C14 : 2
C2 : 1	L1 : 0
C3 : 1	L2 : 0
C4 : 4	L3 : 1
C5 : 10	▶ L4 : 5

### Exit Parameter Setting

Under each parameter setting interface, if there's no button operation on the LCD for more than 1 minute, and then the meter will automatically return to display 1, and the original parameters will be saved.

### Parameter Copy

Set parameters (include general project parameter, P parameter and C parameter) of all KT-LCD8S meter produced by our company according to requirements, and set the LCD to be a data source according to the method of "**C11 LCD attribute selection setting**".

Use special wiring cables to properly wire to LCD8S meter needs to be copied according to the diagram.



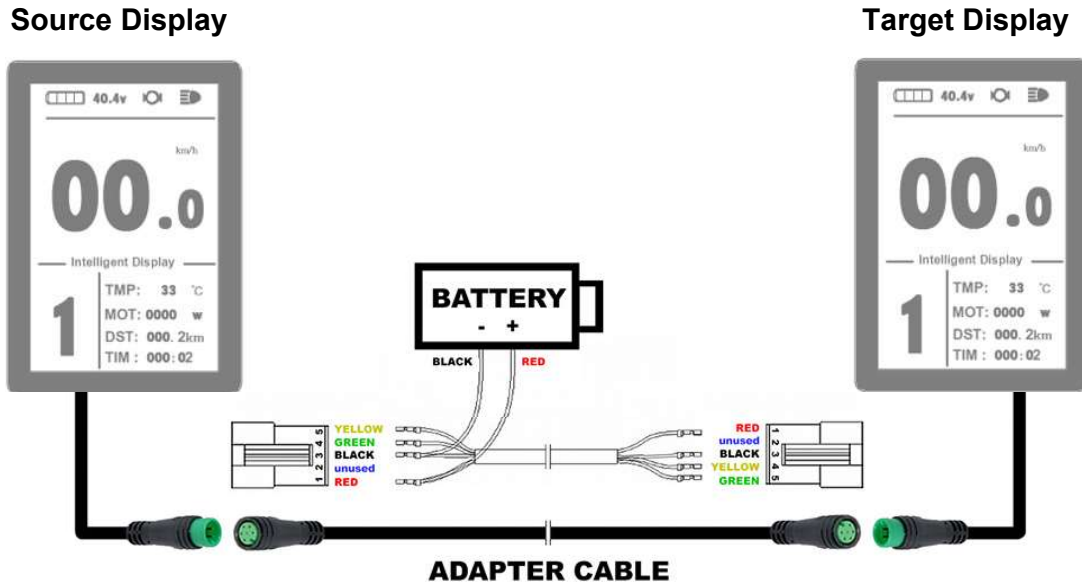

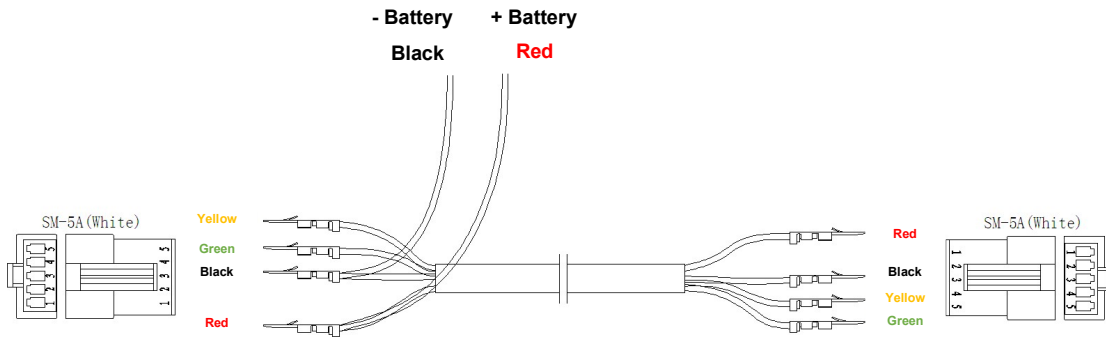

LCD Parameter Copy Wiring Diagram



Special Wiring Cable

Turn on LCD power supply of data source. Power supply of 48V or 36V or 24V is available (VB + positive power supply). After wiring the meter LCD to be copied, hold  button till LCD is powered on. Within 5 seconds after powering up, hold  (UP) button and  (DOWN) button simultaneously for 2 seconds, LCD parameter copy is completed. If the copying operation is correct, the LCD subject to be copied will display as follow.

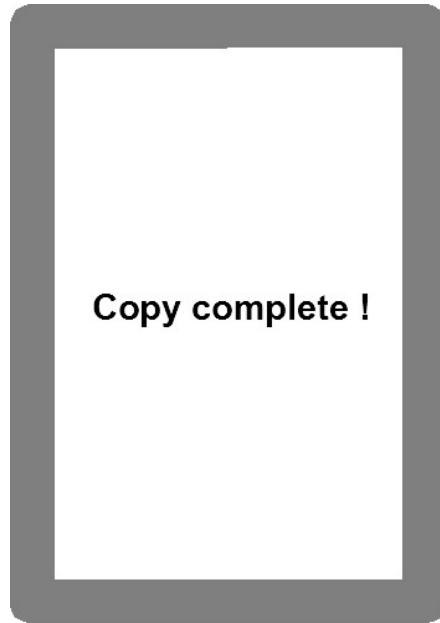

Interface of Finishing Parameter  
Copy

**Please note:** Both C9 power-on password and C11 LCD attributes can't be copied.

LCD8S can only copy parameter of the same LCD model.

### **User Setting Note**

After entering the user parameter setting, if there's no button operation for more than 1 minute, the LCD will automatically return to display 1, and the new set parameters won't be saved.

The factory parameter set value and the default value of the LCD can be set according to user requirements, the LCD parameter can be restored by using "**C10 Restore Default Setting**" approach when adjusting it.

### **Version Information**

KT\_LCD8S\_V1.0

Released on August 20, 2018

## EBO Default Setting

Setting	EBO Values	Description
LIM	72km/h	Maximum Speed Setting <ul style="list-style-type: none"> <li>• 32km/h and Remove Throttle for <b>Class 1</b></li> <li>• 32km/h for <b>Class 2</b></li> <li>• 72km/h or 45km/h for <b>Class 3</b></li> </ul>
DIM	20"	Wheel Diameter
UNT	3	Imperial Units
P1	46, 87 or 100	Motor Gear Reduction Ratio X Rotor Magnets <ul style="list-style-type: none"> <li>• Geared 350W Motors - 87</li> <li>• Geared 500W Motors - 100</li> <li>• Geared 750W Motors - 87</li> <li>• Direct Drive Motors - 46</li> </ul>
P2	0, 1 or 6	Wheel Speed Pulse Signal Setting <ul style="list-style-type: none"> <li>• Gen 1/2 350W Motors - 0</li> <li>• Gen 3 350W Motors - 1, 5, or 6 (Determined by number of magnets and HAL sensor model)</li> <li>• Geared 500W and 750W Motors - 1</li> <li>• Direct Drive Motors - 0</li> </ul>
P3	1	Throttle Assist Level Control Setting
P4	0	Throttle Activation Setting
P5	15	Battery Voltage/Capacity Monitoring
C1	1	Number of Magnets in Pedal Assist Disc <ul style="list-style-type: none"> <li>• BZ-4(8) PAS – 1                             <ul style="list-style-type: none"> <li>○ Lower Sensitivity – 2</li> <li>○ Higher Sensitivity - 0</li> </ul> </li> <li>• BZ-10 PAS - 2</li> <li>• EBO Idler PAS – 2</li> <li>• D12 PAS – 3</li> <li>• V12L PAS - 7</li> </ul>
C2	0	Motor Phase Classification
C3	0	Pedal Assist Level Initialization
C4	2 <b>32</b>	Throttle Function Settings
C5	8	Controller Maximum Current Adjustment
C6	3	Backlight Brightness Adjustment
C7	0	Cruise Control Function
C8	0	Motor Operating Temperature Displayed
C9	0	Password Setting
C10	n	Restore Defaults
C11	0	LCD8SP System Version
C12	4	Controller Maximum Voltage Adjustment
C13	0	ABS Brakes and Anti-Charge Control

C14	2	Pedal Assist Tuning Setting <ul style="list-style-type: none"><li>• Weaker PAS - 1</li><li>• Stronger PAS - 3</li></ul>
L1	0	Automatic Under-Voltage Control
L2	0	Super High-Speed Motor (ONLY) Setting
L3	1	Hall Control System
L4	20	Delay Time of Automatic Shutdown